

KENWOOD

PORTABLE COMPACT DISC PLAYER

DPC-951

DPC-751

DPC-651

DPC-551

INSTRUCTION MANUAL

KENWOOD CORPORATION

Note:

This instruction manual is for common use with the four models above.

Before using the rechargeable battery for the first time:

The rechargeable battery pack provided with this unit has not been charged. Please charge the battery pack before using the unit.

Note for use in automobiles:

If you use the unit in your car, install it in a place not subject to direct sunlight. Also do not leave that unit in car when not in use, for this will cause damage to the unit such as deformation by direct sunlight.

COMPACT
disc
DIGITAL AUDIO

B60-1739-00 (JA) (A) (K,P)
95/12 11 10 9 8 7 6 5

▲ Before applying power

⚠ **Caution:** Read this page carefully to ensure safe operation.

For the U.S.A. and Canada

Important!

Units shipped to the U.S.A. and Canada are designed for operation on 120 volts AC only.

CAUTION: TO PREVENT ELECTRIC SHOCK DO NOT USE THE AC PLUG WITH AN EXTENSION CORD, RECEPTACLE OR OTHER OUTLET UNLESS THE BLADES CAN BE FULLY INSERTED TO PREVENT BLADE EXPOSURE.

For the U.S.A. FCC WARNING:

This equipment may generate or use radio frequency energy. Changes or modifications to this equipment may cause harmful interference unless the modifications are expressly approved in the instruction manual. The user could lose the authority to operate this equipment if an unauthorized change or modification is made.

NOTE:

This equipment has been tested and found to comply with the limits for a CLASS B digital device, pursuant to Part 15 of the FCC Rules. These limits are designed to provide reasonable protection against harmful interference in a residential installation. This equipment may cause harmful interference to radio communications, if it is not installed and used in accordance with the instructions. However, there is no guarantee that interference will not occur in a particular installation. If this equipment does cause harmful interference to radio or television reception, which can be determined by turning the equipment off and on, the user is encouraged to try to correct the interference by one or more of the following measures:

- Reorient or relocate the receiving antenna.
- Increase the separation between the equipment and receiver.
- Connect the equipment into an outlet on a circuit different from that to which the receiver is connected.
- Consult the dealer or an experienced radio/TV technician for help.

For CANADA DOC REGULATION

"This digital apparatus does not exceed the CLASS B limits for radio noise emissions from digital apparatus as set out in the radio interference regulations of the Canadian Department of Communications."

Safety precautions

WARNING: TO PREVENT FIRE OR ELECTRIC SHOCK, DO NOT EXPOSE THIS APPLIANCE TO RAIN OR MOISTURE.

**The marking of products using lasers
(Except for some areas).**

**CLASS 1
LASER PRODUCT**

This label is attached to the bottom panel and says that the component uses laser beams that have been classified as Class 1. It means that the unit is utilizing laser beams that are of a weaker class. There is no danger of hazardous radiation outside the unit.

WARNING NOTICE:

IN MOST CASES IT IS AN INFRINGEMENT OF COPYRIGHT TO MAKE COPIES OF TAPES OR DISCS WITHOUT THE PERMISSION OF THE COPYRIGHT OWNERS. ANYONE WISHING TO COPY COMMERCIALY AVAILABLE TAPES OR DISCS SHOULD CONTACT THE MECHANICAL COPYRIGHT PROTECTION SOCIETY LIMITED OR THE PERFORMING RIGHTS SOCIETY LIMITED.

Special features

Contents



Caution: Read the pages marked  carefully to ensure safe operation.

Portable anywhere

Compatibility with three power supplies including dry cell batteries, car battery and mains power outlet expands the place of your music entertainment.

Easy-to-operate, convenient remote control

A convenient remote control is available as a standard accessory or as an option.

Guard against sound skips: D.A.S.C.

A digital memory prevents sound skips due to vibration or shocks on the unit.

AI (Artificial Intelligence) edit playback

All of the tracks on a disc can be played in a limited period during commuting or on the way to school.

Versatile playback features



Various playback operations including the programming of tracks in desired order, repeated play, shuffle play and scan play are possible.

DSP controlling the tone and live feeling

The DSP (Digital Sound Processor) allows you to select desired tone setup as well as to reproduce live feeling in concert halls.

Convenient features

The Hold feature prevents erroneous operation even when a key is pressed while the unit is in a bag and the Resume feature memorizes the position where playback was last stopped. The unit can also be connected to an optional speaker system.

 Before applying power	2
 Safety precautions	2
 IMPORTANT SAFEGUARDS	4
Accessories	5
Power supply	6
Controls and indicators	9
Preparation	11
Playback from the first track	12
Sound skip guard function(D.A.S.C.)	14
Playback from desired track	15
Programming tracks in desired order	16
AI edit playback	19
Various playback features	20
Playback with desired tone	21
HOLD/RESUME switch	22
Listening through speaker system (optional)	23
Listening through car stereo	24
Maintenance	25
In case of difficulty	26
Specifications	27

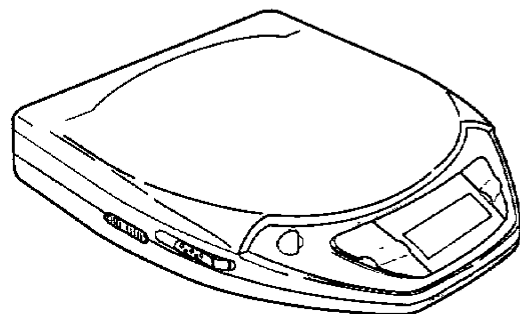

■ IMPORTANT SAFEGUARDS

⚠ **Caution:** Read this page carefully to ensure safe operation.

Please read all of the safety and operating instructions before operating this unit. For best results, follow all warnings placed on the unit and adhere to the operating and use instructions. These safety and operating instructions should be retained for future reference.

- 1. Power sources** — The unit should be connected to a power supply only of the type described in the operating instructions or as marked on the appliance.
- 2. Power-cord protection** — Power-supply cords should be routed so that they are not likely to be walked on or pinched by items placed upon or against them, pay particular attention to cords at plugs, convenience receptacles, and the point where they exit from the unit.
- 3. Enclosure removal** — Never remove the enclosure. If the internal parts are touched accidentally, a serious electric shock might occur.
- 4. Drop** — Do not drop the unit or apply strong shock to it. (Damage due to dropping the unit is not covered by the warranty.)
- 5. Ventilation** — Avoid hindering the ventilation of the unit by covering it with a cloth, etc.
- 6. Abnormal smell** — If an abnormal smell or smoke is detected, immediately turn the power OFF and pull out the power cord. Contact your dealer or nearest service center.
- 7. Heat** — Avoid placing the unit under direct sunlight or near a source of heat such as heating equipment. Particularly, never leave it in an automobile or on the dashboard.
- 8. Temperature** — The unit may not function properly if used at extremely low, or freezing temperatures. The ideal ambient temperature is above +5°C (41°F).
- 9. Water and moisture** — The unit should not be used near water — for example, near a bathtub, washbowl, kitchen sink, laundry tub, in a wet basement, or near a swimming pool, etc.
- 10. Dust and moisture** — Avoid places where is dusty or where the humidity is high.
- 11. Vibrations** — Avoid placing the unit on an unstable place such as a shelf or in a place subject to vibrations.
- 12. Magnetic fields** — Keep the unit away from sources of magnetic fields such as TV sets, speaker systems, radios, motorized toys or magnetized objects.
- 13. Cleaning** — Do not use volatile solvents such as alcohol, paint thinner, gasoline, or benzine, etc. to clean the cabinet. Use a clean dry cloth.
- 14. Nonuse periods** — The power cord of the unit should be unplugged from the outlet when left unused for a long period of time.
- 15. Damage requiring service** — The unit should be serviced by qualified service personnel when:
 - A.** The power-supply cord or the plug has been damaged; or
 - B.** Objects have fallen, or liquid has been spilled into the unit; or
 - C.** The unit has been exposed to rain; or
 - D.** The unit does not appear to operate normally or exhibits a marked change in performance; or
 - E.** The unit has been dropped, or the enclosure damaged.
- 16. Servicing** — The user should not attempt to service the unit beyond that described in the operating instructions. All other servicing should be referred to qualified service personnel.

In case of abnormality, immediately press the open knob to turn the power OFF, and unplug the AC adapter from the power outlet. Then please contact your nearest KENWOOD service center.

Accessories

The standard accessories vary depending on the model of the unit.
The accessories which are not equipped as standard are optionally available. For details, please consult your dealer.

	DPC-951	DPC-751	DPC-651	DPC-551
AC adaptor	○	○	○	○
Audio cord	○	○	×	×
Rechargeable battery	○ (NB-100)	○ (NB-88)	○ (NB-88)	○ (NB-88)
Card remote control unit*	○	○	○	×
Headphone with remote controller	○	○	×	×
Car cassette adaptor	○	○	○	○
Car battery adaptor	○	○	○	○
Carrying case	○	○	×	×
Battery case**	○	○	×	×

*: The card remote control unit can be used with the DPC-951, DPC-751 and DPC-651.
It cannot be used with the DPC-551.

○ : Equipped

** : Battery case can be used with the DPC-951 and DPC-751.
It cannot be used with the DPC-651 and DPC-551.

× : Not equipped

For rechargeable battery: Type NB-88

ATTENTION

Nickel-Cadmium battery must be recycled or disposed of properly.
State laws may vary regarding the handling and disposal of Nickel-Cadmium batteries.
Please contact your Authorized KENWOOD Dealer for more information.

U.S.A. only

For rechargeable battery: Type NB-100

WARNING

- Use specified charger only.
- Do not disassemble or mutilate, may cause burns.
- Do not incinerate or heat, may cause burns, burst or release toxic materials.
- Do not short circuit, may cause burns.
- Keep away from children.

Power supply

This unit can be powered from three kinds of power supplies; batteries, mains power or car battery. (The car battery adapter is needed for car battery operation.)

When using batteries, use alkaline batteries or rechargeable batteries.

This unit holds the stored memory even while the power is set to OFF, and consumes a very small amount of power. Therefore, if the unit is not to be used for a long period (for more than one week), remove the batteries out of the unit.

Mains power operation

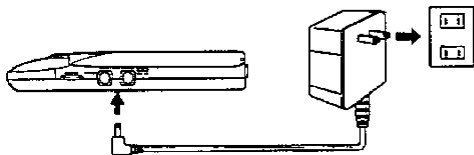

Connect to DC IN jack.

- Never use an AC adapter other than the AC adapter provided with this unit.
- When the unit is not used, unplug the AC adapter from the power outlet.

Dry cell battery operation

① Open the cover.

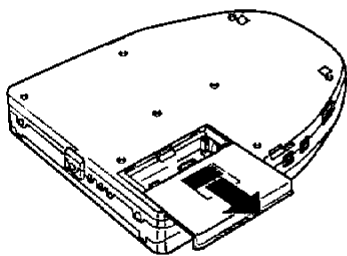

② Insert LR6-size batteries.

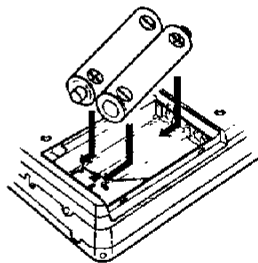

③ Close the cover.

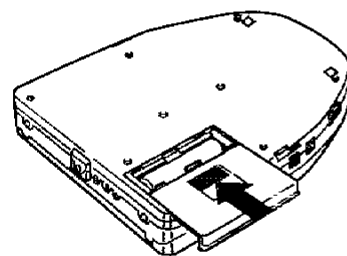

- Be careful not to invert the \oplus and \ominus polarity.
- Always replace both batteries at a time.

Note on rechargeable batteries

(Commercially-available rechargeable batteries cannot be used with this unit.)

The rechargeable batteries should be recharged when they are used for the first time, when they have not been used for a long period or when the battery indicator blinks. The fully-charged status can be attained after about 3 (NB-100)/2 (NB-88/NB-77) hours of recharging. Be sure to use the provided rechargeable batteries or the optional NB-100/NB-88/NB-77. Never use rechargeable batteries other than specified.

Rechargeable battery operation

- ① Insert rechargeable batteries paying attention to the ⊕ and ⊖ polarity.

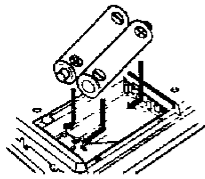

DPC-751/651/551
(NB-88)

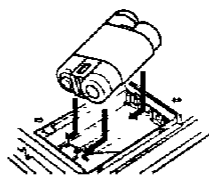

DPC-951
(NB-100)

- ② Start recharging.

1. Set the power OFF. → P.13
2. Plug in the AC adapter.
3. Wait for 5 seconds, then press the  key twice quickly.

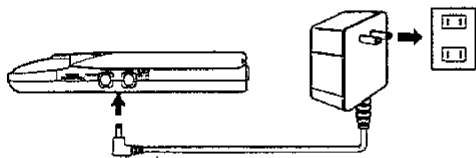

Connect to DC IN jack.



- ③ After recharging, unplug the AC adapter from this unit.

- Be careful not to invert the ⊕ and ⊖ polarity.
- Recharging is not possible during playback. Be sure to set the power OFF before starting recharging.
- The rechargeable batteries can be recharged and re-used for around 500 times. When the possible playback period decreases, purchase the optional NB-100/NB-88/NB-77 rechargeable batteries.
- Be sure to close the top cover of the unit before proceeding to recharging.

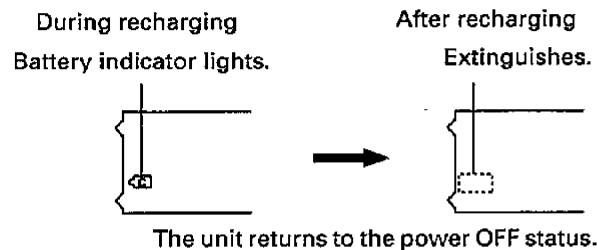

- If batteries are recharged before they are completely empty, full charging may become impossible due to the properties of rechargeable batteries. If this occurs, try to recharge batteries after they have become empty: The batteries capacities will recover gradually.
- Rechargeable batteries cannot be recharged while the external battery case is attached.
- Do not attach the battery case during recharging.

External battery case operation (DPC-951/751 only)

- ① Remove the cover of the battery case.

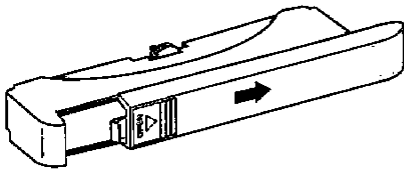

- ② Insert alkaline batteries (LR6).

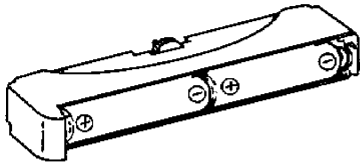

- ③ Close the cover.

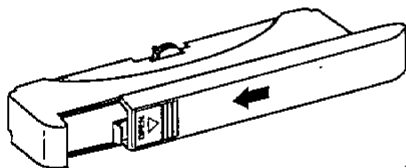

- ④ Attach to the main unit.

Secure by turning the screw in the direction of the arrow.

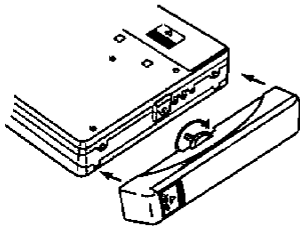

- Be careful not to invert the \oplus and \ominus polarity.

Note



If the battery case is not to be used for a long period, detach it from the main unit. Otherwise, the power of the LR6-size dry cell batteries will be recharged to the rechargeable batteries and the dry cell battery will be exhausted quickly.

Also remove the dry cell batteries from the battery case.

Controls and indicators

Main unit (The illustration shows the DPC-951.)

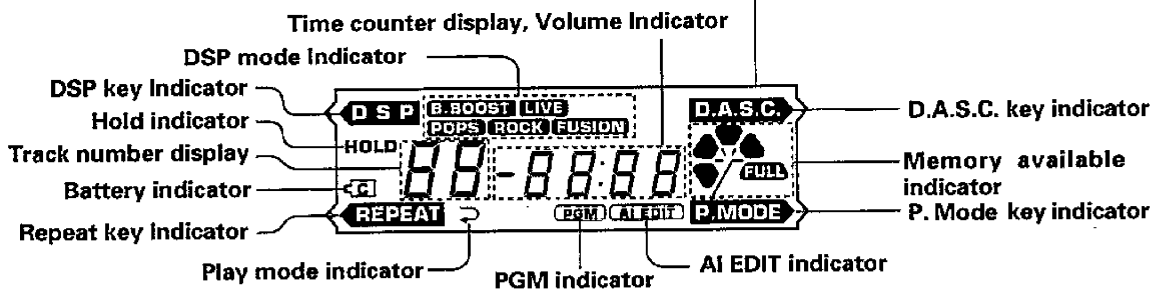
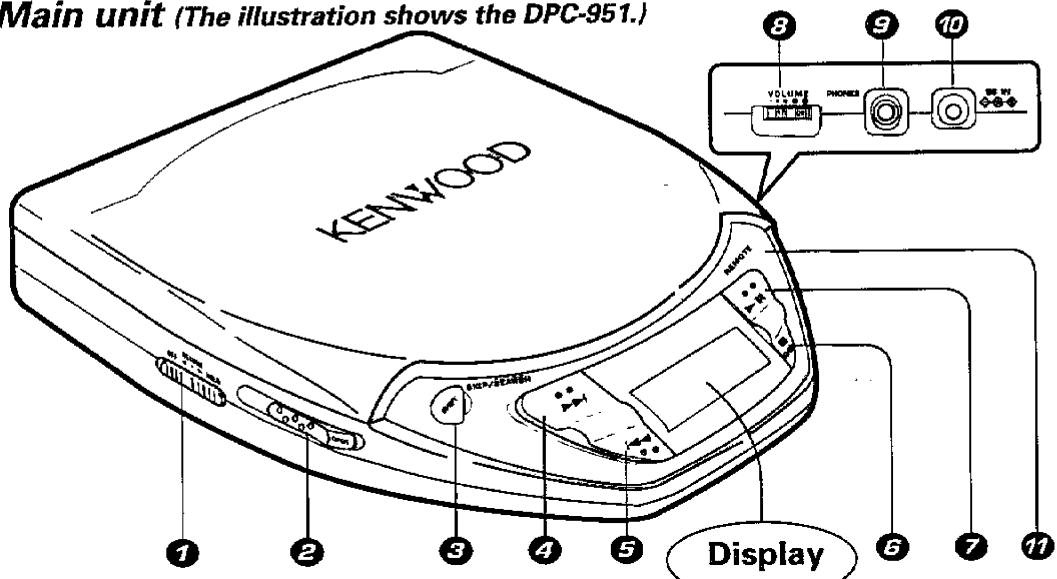

- 1** HOLD/RESUME switch
- 2** OPEN knob
Press to open the top cover.
- 3** SHIFT key
Press to change the functions of some keys. The functions of the following keys change for about 5 seconds after the SHIFT key is pressed.
 - ▶▶▶ key → DSP key
 - ◀◀◀ key → REPEAT key
 - ▶|| key → D.A.S.C. key
 - key → P.MODE key
- 4** ▶▶▶ key/DSP key
▶▶▶ key: Press for track selection by forward track skip or for fast forward operation.
DSP key (when SHIFT is ON): Press to select one of the six tones.
- 5** ◀◀◀ key/REPEAT key
◀◀◀ key: Press for track selection by backward track skip or for fast reverse operation.
REPEAT key (when SHIFT is ON): Press to select one of the four playback modes.
- 6** ■ key/P.MODE (Play mode) key
■ key: Press during playback to stop playback or press in stop mode to turn power OFF. This key is also used when recharging rechargeable batteries. P.MODE key (when SHIFT is ON): Press to activate programmed playback or AI edit playback.
- 7** ▶|| key/D.A.S.C. key
▶|| key: If a disc has been loaded, it starts to play at the same time.
Press during playback to pause it, and press again to restart playback.
D.A.S.C. key (when SHIFT is ON): Press to switch the sound skip guard function ON/OFF.
- 8** VOLUME control
Turn to adjust the listening level.
- 9** PHONES (Headphones) jack
- 10** DC IN jack
When the unit is powered from the mains power, connect the AC adapter to this jack.
- 11** Remote sensor (DPC-951/751/651)

Headphones with remote controller (DPC-951/751)

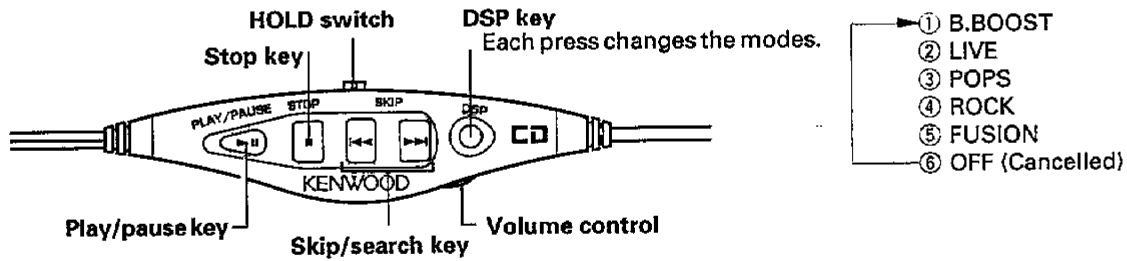

How to use the bag clip

① Fit the clip onto the headphone cord.

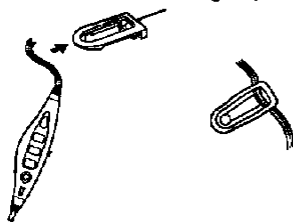

② Attach the clip to a pocket or bag.

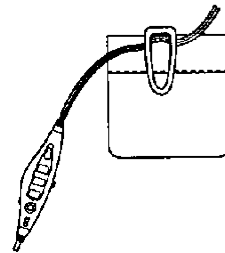

Card remote control unit for exclusive use with DPC-951/751/651

(This cannot be used with the DPC-551.)

When the card remote control unit is used, connect the AC adapter or car battery adapter to the main unit. The card remote control unit cannot be used if the main unit is powered from batteries.

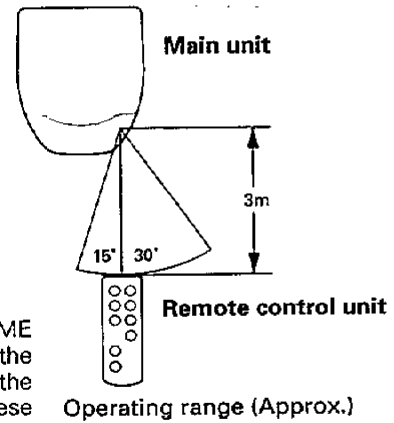
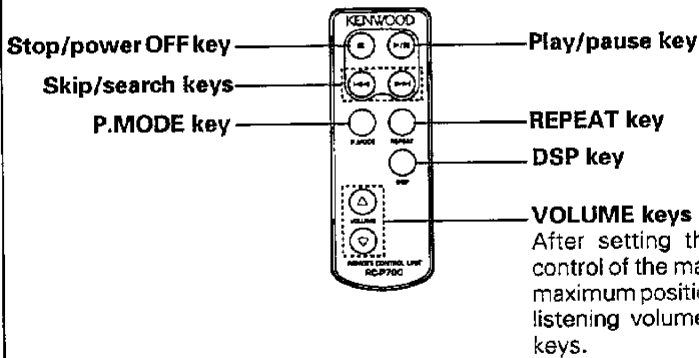

The keys with the same names as the keys on the main unit function the same as the keys on the main unit.

- When pressing several operation keys on the remote control unit, leave an interval of more than 1 second between keys.
- Erroneous operation may occur when the main unit is illuminated by direct sunlight or the light of a high-frequency lighting (inverter) fluorescent lamp. In such a case, change the unit position to prevent erroneous operation.
- For battery replacement, use a commercially-available lithium battery (CR2025).

Preparation

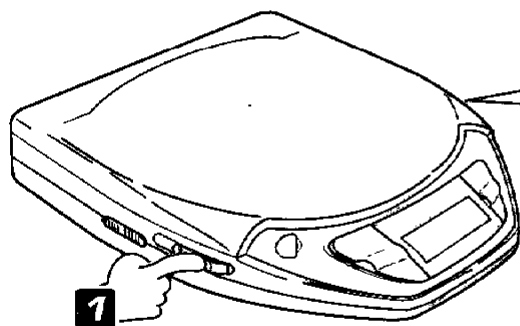

Headphone connection

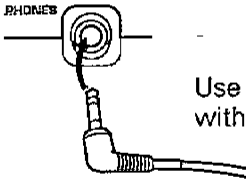

Use headphones equipped with a stereo mini-plug.

1 Open the top cover.

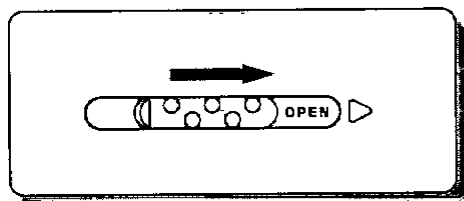

2 Place a disc.

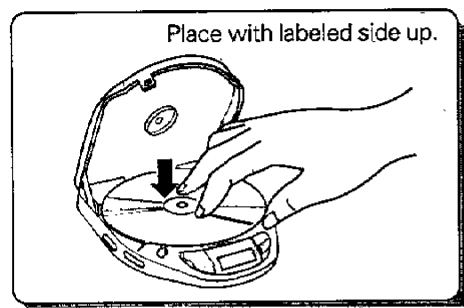

.....

- Fit the disc by pushing a position near the center hole until it clicks.

3 Close the top cover.

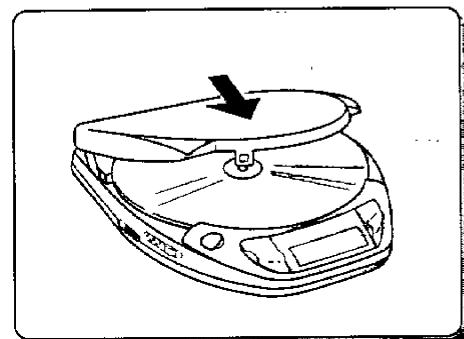

.....

- Close securely by pushing the front left position of the top cover until it clicks.

▶ Playback from the first track

Before any operation, be sure to set the **HOLD/RESUME** switch to the OFF or RESUME position.

→ P.22

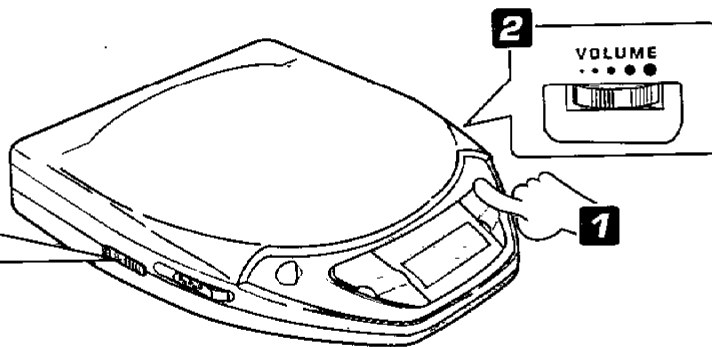
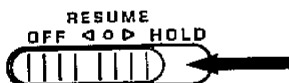

1 Start playback.

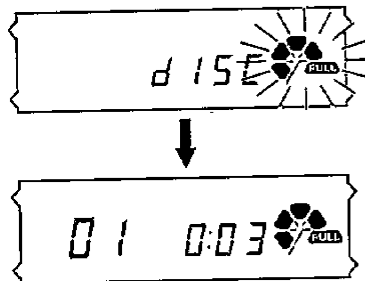
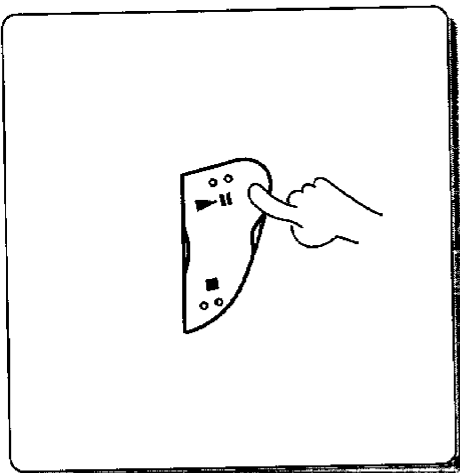

Track number Elapsed time of the track

- During operation using AC adapter or car battery adapter....
The display is illuminated while the power is ON.
During battery operation....
The display is illuminated for about 5 seconds whenever a key is operated.

2 Adjust the volume.

To increase volume
To decrease volume

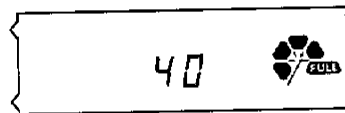
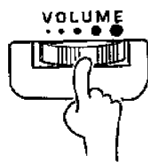

Volume display (0 to 62)

- When listening through headphones with remote controller, set the volume of the player to around 40 and adjust with the volume control of the remote controller.

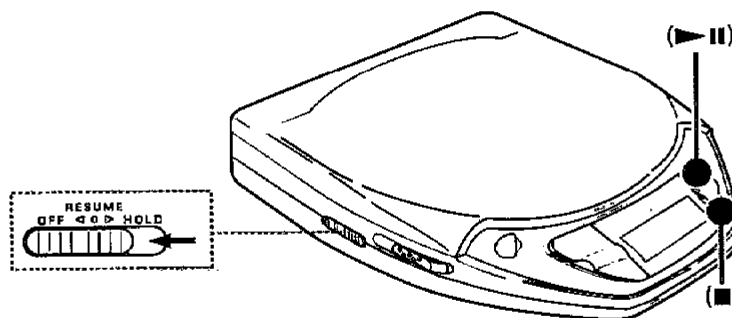

To pause playback temporarily:

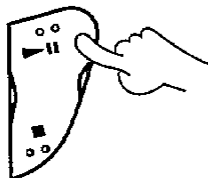

- When the ▶|| key is pressed during playback, it pauses temporarily. Pressing the key again resumes playback.

To stop playback:

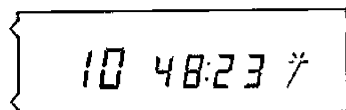
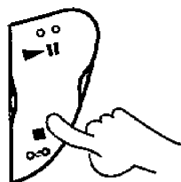

- The total number of tracks and the total playing time of them will be displayed.
- When the **HOLD/RESUME** switch is in the RESUME position, the track number where the playback was stopped and the elapsed time until there will be displayed.

To turn power OFF:

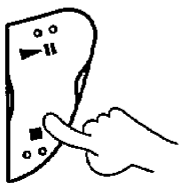

After stopping playback, press the ■ key again.

- The displayed contents disappear when the power is turned OFF.

Auto power-Off function

If no operation key has been pressed for 3 minutes while the unit is in the stop mode, the power is turned OFF automatically to prevent battery power consumption.

4 Sound skip guard function (D.A.S.C.)

This unit incorporates the D.A.S.C. function for guarding against sound skip. It prevents sound skip by storing the digital data corresponding to about 3 seconds of CD playback in memory and plays sound while reading the data from the memory.

Mechanism of D.A.S.C.

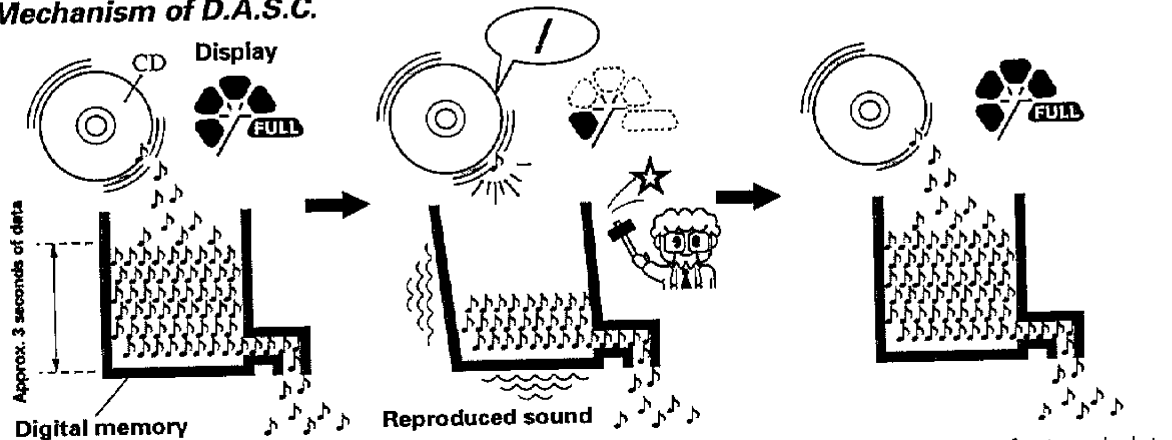

During playback, the CD is rotated at double the normal speed and the sound data of about 3 seconds beyond the present playback position is stored in memory.

When the readout from the CD is interrupted due to a vibration or shock, the sound data read from the memory is not interrupted.

The amount of stored data recovers so that the circuit can deal with the next possible shock.

- In case of vibration above a certain degree, the memory data may be exhausted and the guard from sound skip may become temporarily ineffective.

Switching D.A.S.C. ON/OFF

The use of the D.A.S.C. sound skip guard results in quick discharging from the batteries. When you play the unit in a place not subject to vibration, it is recommended to switch the D.A.S.C. OFF to prolong the battery life.

- 1 Press the SHIFT key.



- 2 Press the D.A.S.C. key.



The reproduced sound is interrupted during switching.

- Proceed to step 2 within 5 seconds after pressing the SHIFT key.

Each press of the D.A.S.C. key switches it ON/OFF alternately.

- 1 D.A.S.C. OFF The memory available indicator goes off.

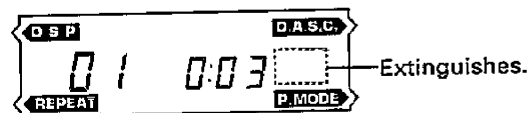

- 2 D.A.S.C. ON The memory available indicator lights.

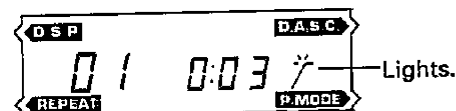

Playback from desired track

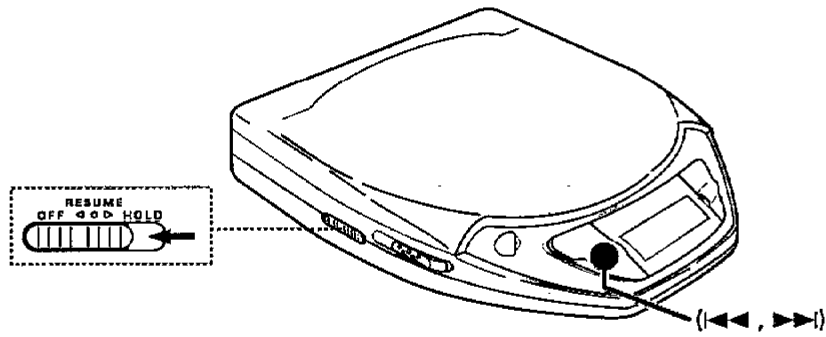

Track selection by track skip

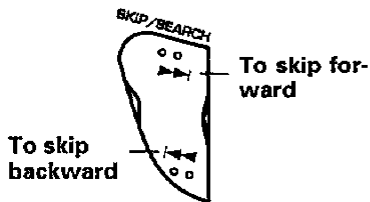

- The same number of tracks as the times the key is pressed can be skipped.
- When the  key is pressed once during playback, the played position returns to the beginning of the current track being played.

Fast forward, fast reverse

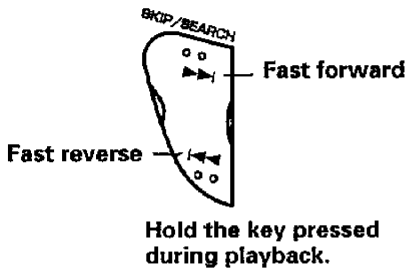

- Playback resumes from the position where the key is released.
- If the key is released immediately after it has been pressed, the same operation as the track skip operation occurs.
- Fast forward and fast reverse operations are not possible during scan playback or AI edit playback.

6 Programming tracks in desired order

Preparations

- Enter the stop mode by pressing the  key while a track number is displayed.
- Set the HOLD/RESUME switch to the OFF or RESUME position.

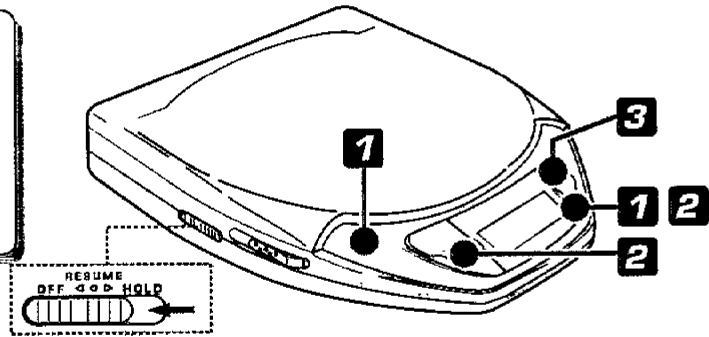

1 Enter the PGM mode.

① Press the SHIFT key.



② Press the P.MODE key.

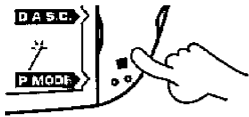

- Proceed to step ② in less than 5 seconds after pressing the SHIFT key.

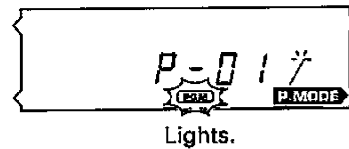

2 Select the desired track numbers in the order you want to play them.

① Select a track....

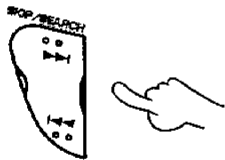

② And enter it.

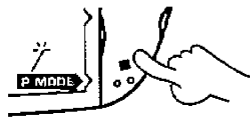

Track number blinks during selection.

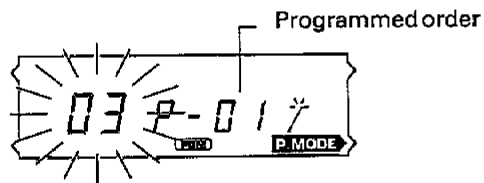

- Select other tracks in the desired order by repeating ① and ② above.
- Up to 20 tracks can be programmed at a time.

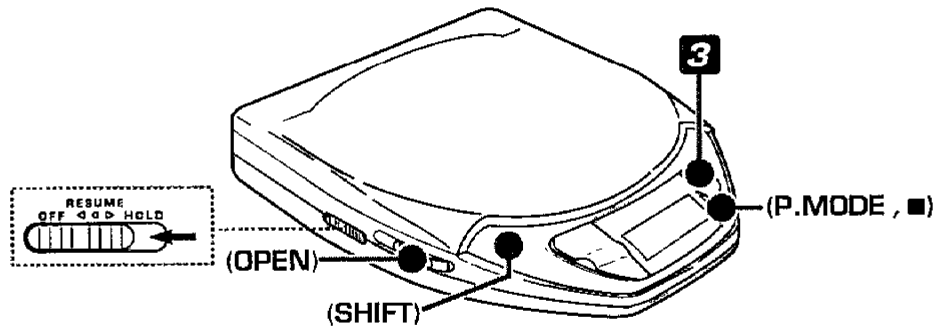

3 Start playback.

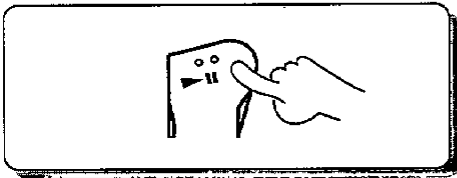

To check the programme contents

- ① Enter the stop mode.

- ② Press the **SHIFT** key.
(Go to next step in less than 5 seconds.)

- ③ Press the **P.MODE** key.

Track number Programmed order

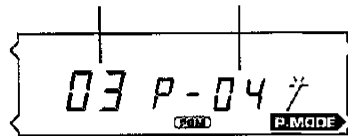

- Each press displays the next track number in the programmed order.

To clear the programme:

- ① Enter the stop mode.

- ② Press the **■** key.

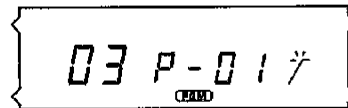
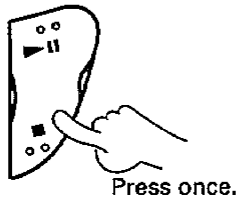

- The program can also be canceled by pressing the OPEN knob.

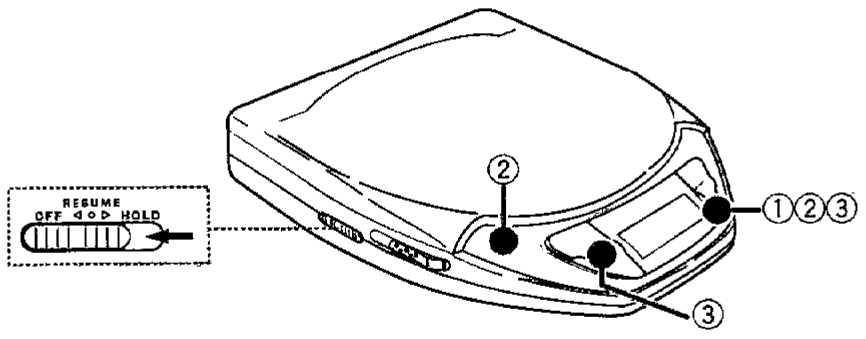

To change a programmed content:

① Enter the stop mode.

② Display the content to be changed.

① Press the SHIFT key.



② Press the P.MODE key.



③ Change the track number.

Select the desired track number.

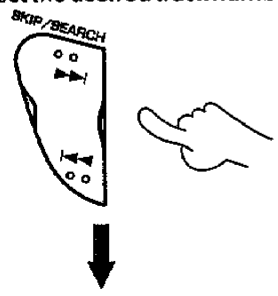

Enter it in the programme.

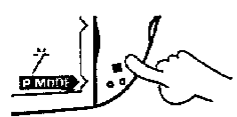

- Proceed to step ② in less than 5 seconds after pressing the SHIFT key.

- Press the key repeatedly until the programmed order containing the track number to be changed is displayed.

Track number Programmed order

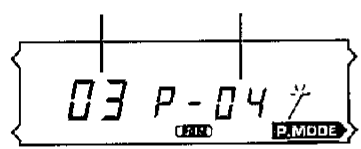

AI edit playback



AI edit playback plays all of the tracks on a disc within the set time period by fading out (reducing volume gradually at the end of) every track. (Fast forward and fast reverse operations are not possible.)

Preparations

- Enter the stop mode by pressing the  key while a track number is displayed.

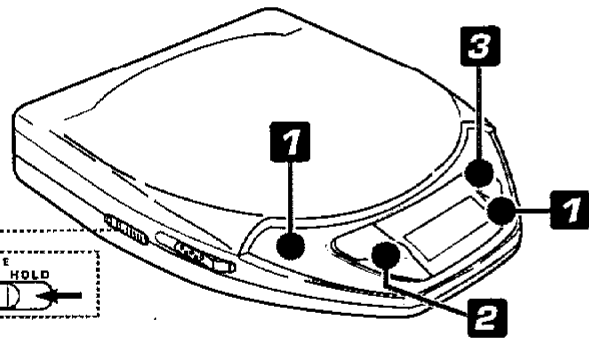
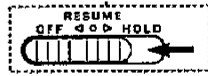

1 Enter the AI edit mode.

- Press the SHIFT key.



- Press the P.MODE key twice.

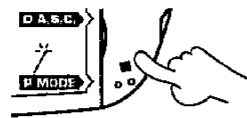

- If the unit has been in the program or repeat mode, cancel the program mode or repeat mode.
- Proceed to step ② in less than 5 seconds after pressing the SHIFT key.

Display after the first press of the P.MODE key

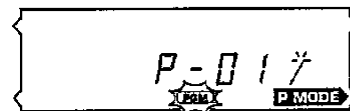

After the second press

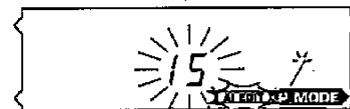

Lights.

2 Select the time period available for playback.

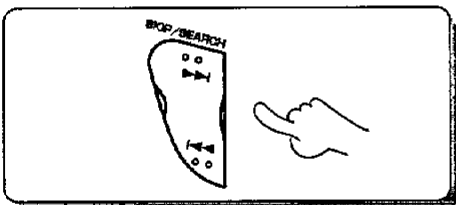

Each press of the key switches the time periods as follows.

- ① 15 (min.)
- ② 30
- ③ 45
- ④ 60

3 Start playback.

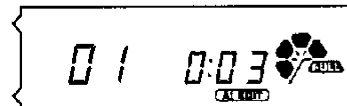
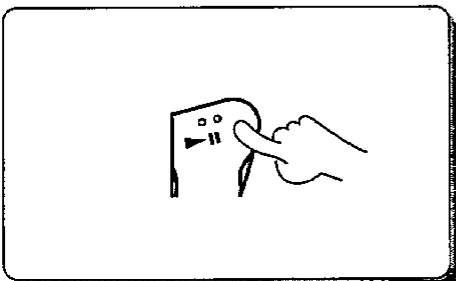

- If the disc contains too many tracks and the set time period is too short, all of the disc tracks may sometimes be unable to be played.
- The AI edit mode can be canceled by pressing the  key in stop mode.

20 Various playback features

Pressing the REPEAT key in the play or stop mode allows you to enjoy various playback features.

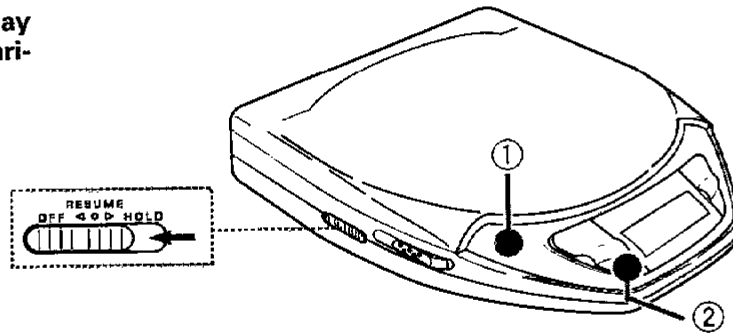

① Press the SHIFT key.

② Press the REPEAT key.

- Proceed to step ② in less than 5 seconds after pressing the SHIFT key.

- Each press of the REPEAT key switches the playback modes.
- In case random play or scan play is selected during playback, the playback of the selected mode starts after the current track being played has completed.
- The REPEAT key is invalid during AI edit playback.

① **One-track repeat**
The track being played or selected track will be played repeatedly.

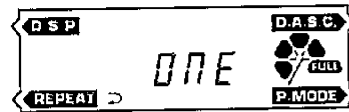

② **All-track repeat**
All tracks on the disc will be played repeatedly.

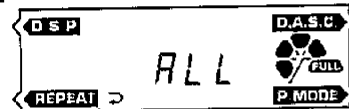

③ **Shuffle play**
All tracks on the disc or all of the programmed tracks will be played in a random order.

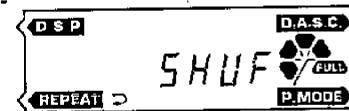

④ **Scan play**
A part of every track on the disc will be played for 20 seconds.
(Fast forward or fast reverse operation is not possible.)

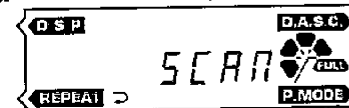

⑤ **Canceled position**
Returns to the normal play mode.

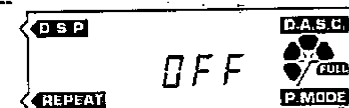

Playback with desired tone



The Digital Sound Processor allows you to select tone set-ups according to the genre of music or to provide a live feeling like in a concert hall.

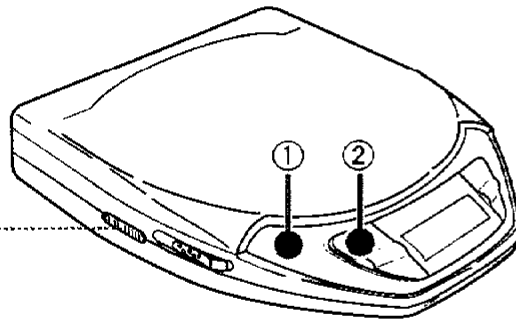
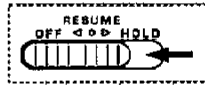

① Press the SHIFT key.



② Press the DSP key.



- Proceed to step ② in less than 5 seconds after pressing the SHIFT key.

- Each press of the DSP key switches the modes. Enjoy music with the desired tone.

① B.BOOST (Bass boost)



② LIVE

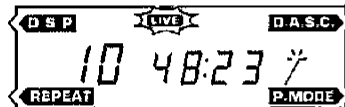

③ POPS

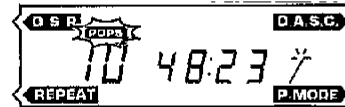

④ ROCK



⑤ FUSION



⑥ OFF

Returns to the original tone of music.

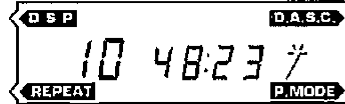

72 **HOLD/RESUME switch**

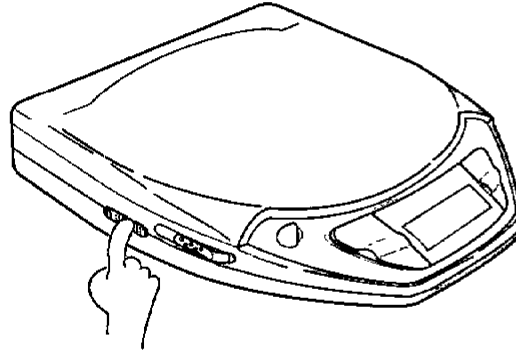

RESUME position

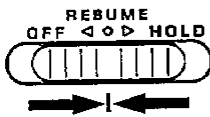

Set to the center position.

HOLD position



Set to the right position.

The next playback starts from the position where it was last stopped. This feature is convenient when the unit is played using a car battery adapter because the played position does not return to the first track when the power is turned OFF.

- To maintain the memory, be sure to leave the rechargeable batteries or dry cell batteries in the unit.
- If playback is restarted in more than 1 minute after playback was stopped or power was turned OFF, the playback starts from the beginning of the track which was played last.
- If the top cover is opened, the memory of the position where playback was stopped is cleared and the next playback will start from the first track.
- When operating only with batteries, the memory is effective for one minute after the power was turned off.

The operation keys of the main unit except for the **OPEN** knob and volume control are defeated.

This position prevents undesired operation when the unit is put in a bag, etc.

Lights.

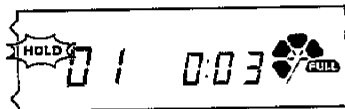

- To maintain the memory, be sure to leave the rechargeable batteries or dry cell batteries in the unit.
- Before operating the unit in any way, be sure to set the switch to a position other than the HOLD position. Operation is not possible while the switch is in the HOLD position.
- The memory is also effective when the switch is in the HOLD position.

Listening through speaker system (optional)

The unit can be played through a KENWOOD active speaker system (AS-5: optional).

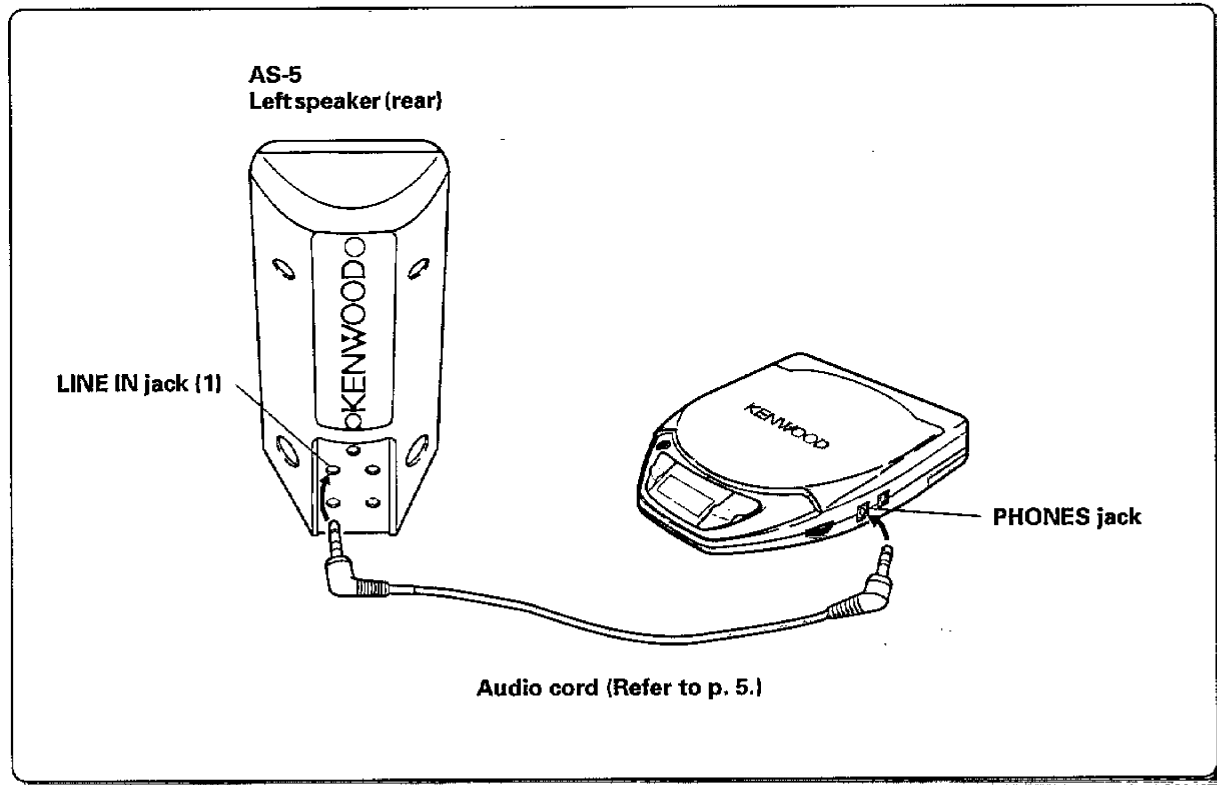
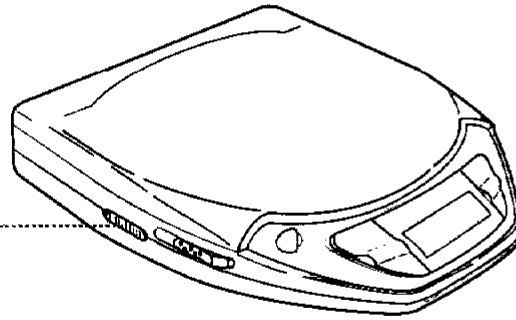
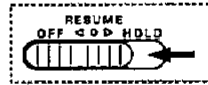

- The volume should be adjusted on the speaker system. (The volume should be adjusted in combination with the volume control of the CD player.)

Note



Be sure to turn the power of the speaker system OFF before connecting the cord.

24 Listening through car stereo

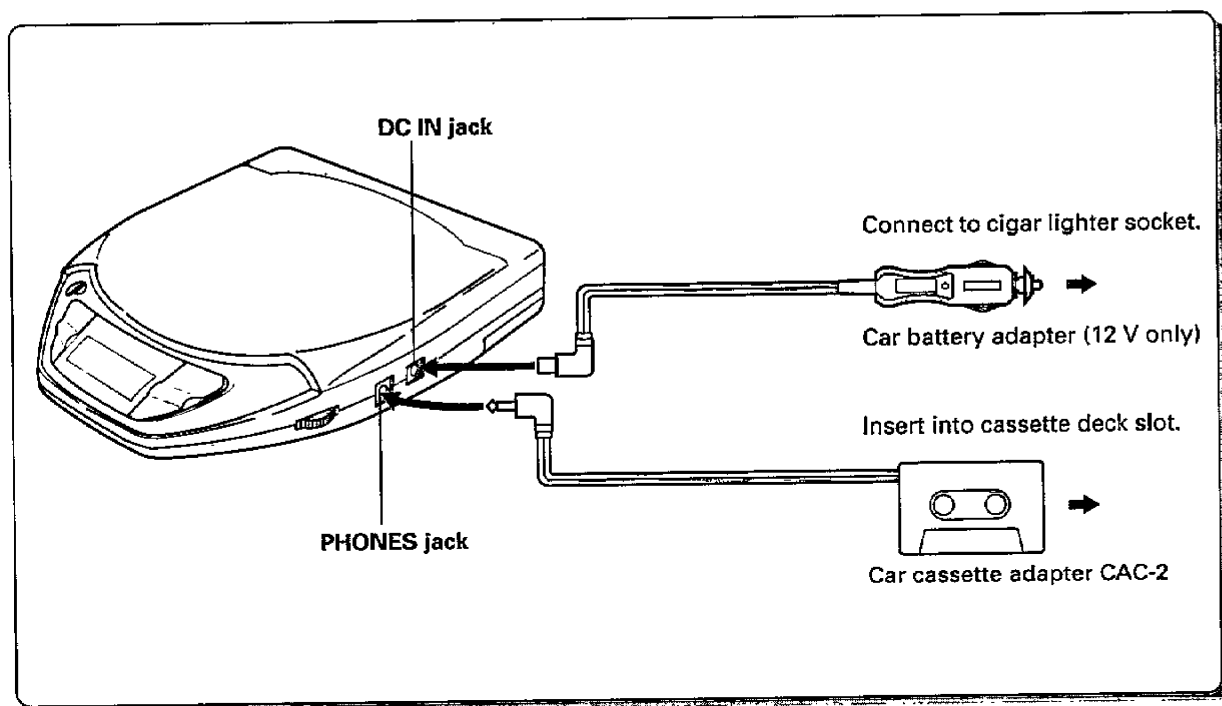

- Place the unit in a stable position not subject to the vibrations of the car.
- The plug may not match the cigar lighter socket of some car models.
- If sound is not produced, change the tape playing direction of the car stereo.
(Sound is not produced if the car stereo is set to play tape side B.)
- The sound reproduction may not be possible with some car stereo models.

Notes



1. If the unit cannot be operated with the car battery adapter connected, suspect the possibility of a blown fuse. The fuse can be replaced by turning the electrode on the tip of the adapter plug. When replacing the fuse, be sure to use a fuse with a rating of 1 A.
2. Do not leave the products or batteries in the car, particularly above the dashboard, for this may lead to malfunction or damage due to solar heat.
3. When the unit is not used, unplug the car battery adapter. (Otherwise, the car battery may run out, with some car models.)
4. If the unit is connected to a car stereo using an audio cord, noise may sometimes interfere.

In case of abnormality such as smoke production, immediately unplug the car battery adapter from the cigar lighter socket.

Maintenance

Simple care

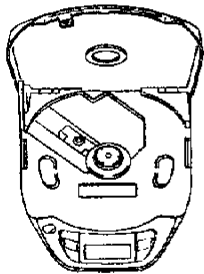

Care of lens

- Dirt on the lens may cause failure including inability to playback. Clean the lens using a commercially-available camera blower, etc. Do not use commercially-available lens cleaner or disc cleaner, for these agents may damage the equipment.

Care of main unit

- When the unit gets dirty, clean with a soft, dry cloth. If the unit is stained seriously, a moistened cloth can be used. Do not use benzine or thinner for these will damage the unit.

Cleaning the plug

- Wipe the headphone plug with a soft cloth to maintain it always clean. A dirty plug may cause noise or malfunction.

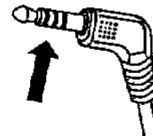

Disc handling precautions

Handling

Hold compact discs so that you do not touch the playing surface. Do not attach paper or tape to either the playing side or the label side of compact discs.

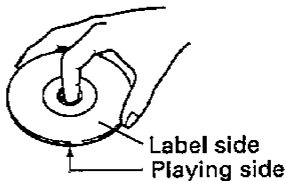

Cleaning

If fingerprints or foreign matter become attached to the disc, lightly wipe the disc with a soft cotton cloth (or similar) from the center of the disc outwards in a radial manner.

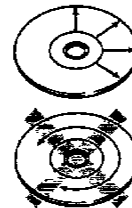

Storage

When a disc is not to be played for a long period of time, remove it from the CD player and store it in its case.

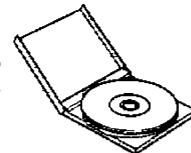

Caution on disc used

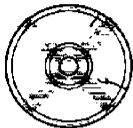

Never play a cracked or warped disc.

During playback, the disc rotates at high speed in the player. Therefore, to avoid danger, never use a cracked or deformed disc or a disc repaired with tape or adhesive agent.

Note on music copyright

The copyright law in your country inhibits the use of the recording you made without the permission of the copyright owners unless you use it for your personal entertainment.

For the U.S.A.

CAUTION:

Use of controls or adjustments or performance of procedures other than those specified herein may result in hazardous radiation exposure.

In compliance with Federal Regulations, following are reproductions of labels on, or inside the product relating to laser product safety.

KENWOOD CORPORATION
2967-3, ISHIKAWA-CHO,
HACHIOJI-SHI,
TOKYO, JAPAN

KENWOOD CORP. CERTIFIES THIS EQUIPMENT
CONFORMS TO DHHS REGULATIONS NO. 21
CFR 1040.10, CHAPTER I, SUBCHAPTER J.

Location: Bottom Panel

26 In case of difficulty

What seems to be a serious trouble may sometimes be due to simple mistake. Before calling for service, check the items shown in the following table again. (If you request servicing due to the reasons shown in the table, the service may be charged in some cases.)

Symptom	Cause	Remedy
No operation occurs when operation keys are pressed.	<ul style="list-style-type: none"> The HOLD/RESUME switch of the main unit or remote controller is set to "HOLD". The batteries are exhausted. The disc is placed upside down. Condensation occurred inside the unit. The AC adapter is unplugged. 	<ul style="list-style-type: none"> Set the switch to other position than "HOLD". Replace both of the two dry cell batteries, or recharge the rechargeable batteries. Place the disc with the labeled side up. Leave the unit for about 1 hour before re-use. Connect properly.
No sound is heard from the headphones.	<ul style="list-style-type: none"> The headphones are connected incompletely. The volume is set to the minimum position on the main unit or remote controller. 	<ul style="list-style-type: none"> Insert the plug securely into the PHONES jack. Adjust the volume on the main unit or remote controller.
Sound skips, or is interrupted.	<ul style="list-style-type: none"> The D.A.S.C. is set to "OFF". A strong vibration that exceeds the capacity of the D.A.S.C. occurred. The disc is dirty. The lens is dirty. The headphone plug is dirty. The batteries are weak. 	<ul style="list-style-type: none"> Set the D.A.S.C. to "ON". Place the unit in a place not subject to vibrations. Clean it. Clean it. Clean it. Replace or recharge the batteries.
Noise interferes.	<ul style="list-style-type: none"> The headphone plug is dirty. The batteries are weak. The headphones are connected incompletely. 	<ul style="list-style-type: none"> Clean it. Replace or recharge the batteries. Insert the plug securely into the PHONES jack.
Rechargeable batteries cannot be recharged.	<ul style="list-style-type: none"> Commercially-available rechargeable batteries are used. 	<ul style="list-style-type: none"> Use the exclusive rechargeable batteries (NB-100/NB-77/NB-88).

Notes



- This system uses a microcomputer so it may malfunction due to external noise or interference. In such a case, unplug the power cord then plug it again (or remove the batteries and insert them again).
- Do not use contact cleaner for this could cause malfunction. Particularly, contact cleaner containing oil may deform plastic parts.
- Erroneous operation may occur when the headphone plug is plugged or unplugged; but this is not a malfunction.

Specifications



Format

System Compact disc digital audio system
Laser Semiconductor laser

Audio

Frequency response 20 Hz ~ 20 kHz, ± 3 dB
PHONES output level/impedance max. 1 V/22 Ω
(Headphone output: 16 Ω , 1 kHz 9 mW + 9 mW)

General

Power supply

External DC supply DC 12 V
Supplied rechargeable battery (DPC-951: NB-100 (1), DPC-751/651/551: NB-88 (2)) DC 2.4 V
Commercially-available alkaline batteries (LR6, AA) $\times 2$ DC 3 V

Battery life (continuous repeat playback (D.A.S.C. ON))

Commercially-available alkaline batteries (2) Approx. 4.5 hours
Supplied rechargeable battery (DPC-951) Approx. 4 hours
(DPC-751/651/551) Approx. 2.5 hours

With 2 commercially-available alkaline batteries and supplied rechargeable battery

(DPC-951) Approx. 9.5 hours
(DPC-751/651/551) Approx. 8 hours

With 4 commercially-available alkaline batteries

Approx. 12 hours

Battery life (continuous repeat playback (D.A.S.C. OFF))

Commercially-available alkaline batteries (2) Approx. 5.5 hours
Supplied rechargeable battery (DPC-951) Approx. 4.5 hours
(DPC-751/651/551) Approx. 3 hours

With 2 commercially-available alkaline batteries and supplied rechargeable battery

(DPC-951) Approx. 11 hours
(DPC-751/651/551) Approx. 9.5 hours

With 4 commercially-available alkaline batteries

Approx. 16 hours

Dimensions

W: 128 mm (5 - 1/16")
H: 27 mm (1 - 1/16")
D: 157 mm (6 - 3/16")

Weight (net)

(DPC-951) 274 g (9.7 oz)
(DPC-751/651/551) 270 g (9.5 oz)

Note:

KENWOOD follows a policy of continuous advancements in development. For this reason specifications may be changed without notice.



Dear Customer:

Selecting fine audio equipment such as the unit you've just purchased is only the start of your musical enjoyment. Now it's time to consider how you can maximize the fun and excitement your equipment offers. This manufacturer and the Electronic Industries Association's Consumer Electronics Group want you to get the most out of your equipment by playing it at a safe level. One that lets the sound come through loud and clear without annoying blaring or distortion — and, most importantly, without affecting your sensitive hearing.

Sound can be deceiving. Over time your hearing "comfort level" adapts to higher volumes of sound. So what sounds "normal" can actually be loud and harmful to your hearing. Guard against this by setting your equipment at a safe level BEFORE your hearing adapts.

To establish a safe level:

- Start your volume control at a low setting.
- Slowly increase the sound until you can hear it comfortably and clearly, and without distortion.

Once you have established a comfortable sound level:

- Set the dial and leave it there.

Taking a minute to do this now will help to prevent hearing damage or loss in the future. After all, we want you listening for a lifetime.

We Want You Listening For A Lifetime

Used wisely, your new sound equipment will provide a lifetime of fun and enjoyment. Since hearing damage from loud noise is often undetectable until it is too late, this manufacturer and the Electronic Industries Association's Consumer Electronics Group recommend you avoid prolonged exposure to excessive noise. This list of sound levels is included for your protection.

Decibel

<u>Level</u>	<u>Example</u>
30	Quiet library, soft whispers
40	Living room, refrigerator, bedroom away from traffic
50	Light traffic, normal conversation, quiet office
60	Air conditioner at 20 feet, sewing machine
70	Vacuum cleaner, hair dryer, noisy restaurant
80	Average city traffic, garbage disposals, alarm clock at two feet.

THE FOLLOWING NOISES CAN BE DANGEROUS UNDER CONSTANT EXPOSURE

90	Subway, motorcycle, truck traffic, lawn mower
100	Garbage truck, chain saw, pneumatic drill
120	Rock band concert in front of speakers, thunderclap
140	Gunshot blast, jet plane
180	Rocket launching pad

Information courtesy of the Deafness Research Foundation.